

## Technical Data Sheet F Series

### Basic Info

KSF F 76x1600-R	KSF F 76x1300-R	KSF F 76x1000-R	KSF F 76x800-R
<b>Nominal length (mm)</b>			
1600	1300	1000	800
<b>Tube diameter (mm)</b>			
76.10	76.10	76.10	76.10
<b>Weight (kg)</b>			
12.00	7.50	6.00	4.50
<b>Item number</b>			
25478	25477	25476	25475

### Construction

- Flange: Sheet metal S355
- Continuous welded helix
- Coating: Hot-dip galvanized according to DIN EN ISO 1461

### Applications

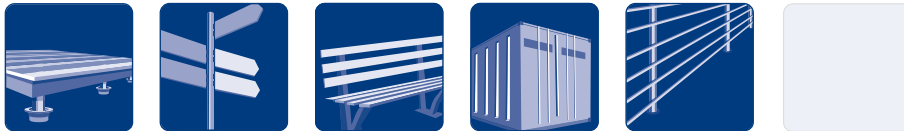

### Accessories



**Post Bearer Plane-R**  
Item No. 28006



**Post Bearer M24-R**  
Item No. 28007



**Post Bearer M44-R**  
Item No. 28008



**Post Bearer Sword-R**  
Item No. 28009



**Post Bearer Side Flaps-R**  
Item No. 28010



**Post Bearer Vario PS150-R**  
Item No. 28019



KSF F 76x1300-R

Subject to technical change!

Krinner Schraubfundamente GmbH | Passauer Straße 55 | D-94342 Straßkirchen  
Phone: +49 9424 9401-80 | E-Mail: service@krinner.com | www.krinner.com

efficient · no concrete · durable

## Technical Data

	KSF F 76x1600-R	KSF F 76x1300-R	KSF F 76x1000-R	KSF F 76x800-R
<b>a</b>	Length (mm) ( $\pm 25$ mm)			
	1575	1275	1045	815
<b>b</b>	Shaft outer diameter (mm)			
	76.10	76.10	76.10	76.10
<b>c</b>	Inner diameter (mm)			
	68.90	70.90	70.90	70.90
<b>d</b>	Hole diameter (mm)			
	6 x $\varnothing 11$	6 x $\varnothing 11$	6 x $\varnothing 11$	6 x $\varnothing 11$
<b>e</b>	Pitch circle diameter (mm)			
	116	116	116	116
<b>f</b>	Flange length (mm)			
	189	189	189	189
<b>g</b>	Flange thickness (mm)			
	5	5	5	5
<b>h</b>	Flange width (mm)			
	140	140	140	140
<b>i</b>	Oblong hole grid size (mm)			
	100	100	100	100
<b>j</b>	Oblong hole length (mm)			
	49	49	49	49
<b>k</b>	Oblong hole diameter (mm)			
	11	11	11	11

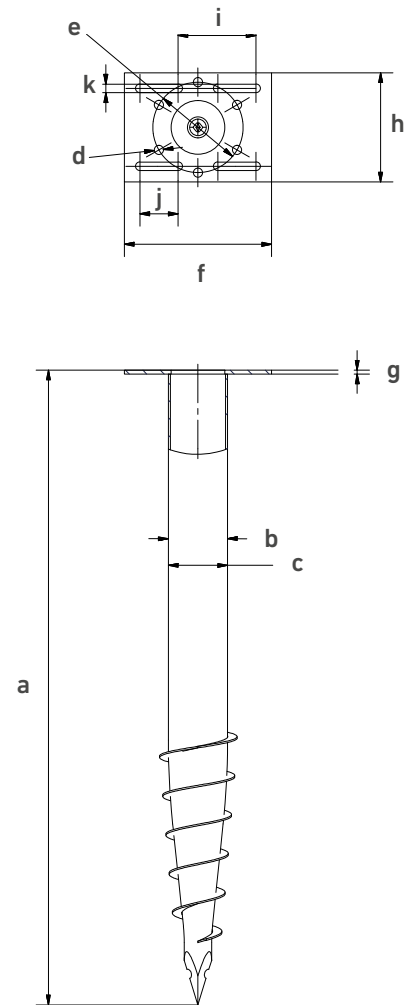

## Online Service

KSF F 76x1600-R	KSF F 76x1300-R	KSF F 76x1000-R	KSF F 76x800-R
-----------------	-----------------	-----------------	----------------

### Webkey

F2547811D



F2547711D



F2547611D



F2547511D



### Post Anchor

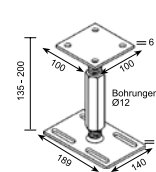

Flat R

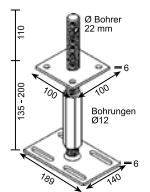

M24-R

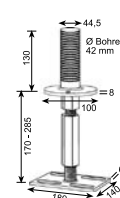

M44-R

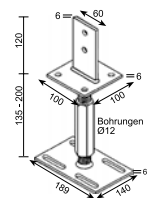

Blade R

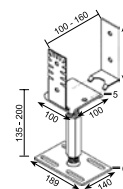

Side Tabs R

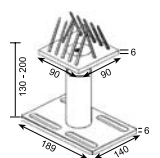

Vario PS 150-R

Subject to technical change!